

Read all instructions before starting installation.

PARTS INCLUDED (Quantity varies by order)

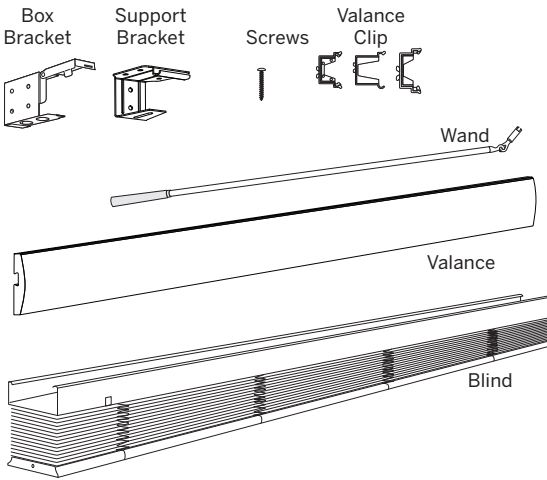

OPTIONAL PARTS

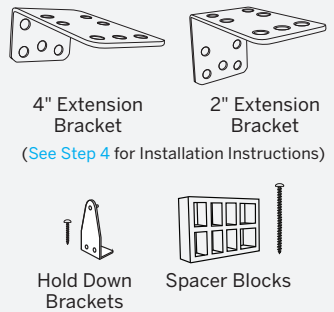

NOTE: Optional items will be included, if selected at time of the blind order. If your package does not include these items, installation can proceed without them.

TOOLS NEEDED

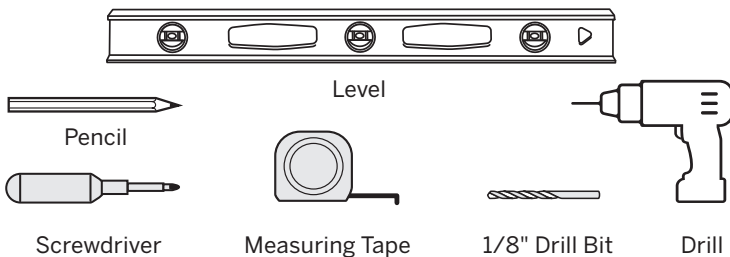

Use the appropriate fasteners for the type of mounting surface as specified below:

- **Drywall or Plaster:** Use wall anchors or expansion bolts (not provided).
- **Metal:** Use sheet metal screws (not provided).
- **Wood:** Use No. 6 hex head screws (provided).

BRACKET INFORMATION

- Your order will include the correct number of installation brackets for your blind width, as shown in the table.
- For the blind to operate correctly, it's important that the brackets are mounted level.
- If needed, use shims to help adjust and align the brackets.
- The number and placement of brackets is the same whether you're installing inside or outside the window frame.

Blind Width	Bracket Quantities	
	End Brackets	Support Brackets
Up to 48"	2	0
48" to 84"	2	1
84" to 96"	2	2
96" to 144"	2	3

1

PLACE BLIND IN DESIRED LOCATION AND MARK EDGES

DON'T FORGET: Before marking bracket locations, check clearance depth required to avoid obstructions such as window cranks or handles.

INSIDE MOUNT

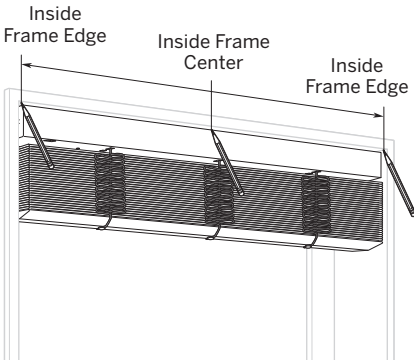

OUTSIDE MOUNT

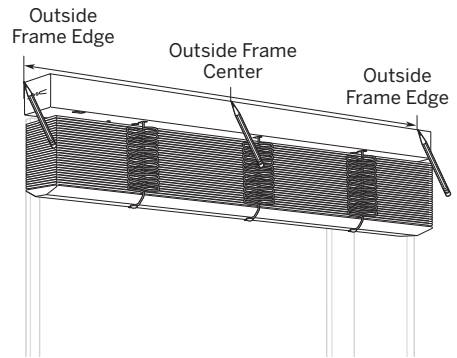

	Minimum Depth	Flush Headrail	Flush Valance
2" Slat	3/4"	2-1/2"	3-1/2"
2-1/2" Slat	1-1/4"	3"	3-7/8"†

Minimum Height
3"

† With Spacer

2

MARK BRACKET LOCATION, CENTER ANY ADDITIONAL BRACKETS IF APPLICABLE

- Position the box brackets at the end of each headrail to confirm the dimension.
- Mark the location of the desired bracket mounting holes, two per bracket, making sure they are square and equally spaced.

INSIDE MOUNT

NOTE: Box brackets on inside mount can be marked for top, back or side attachment.

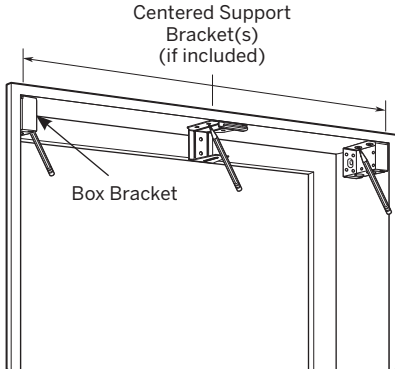

OUTSIDE MOUNT

NOTE: Box brackets on outside mount can only be marked for back attachment.

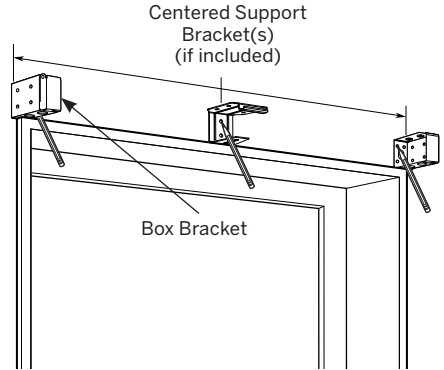

3

PRE-DRILL HOLES USING A 1/8" DRILL BIT

INSIDE MOUNT

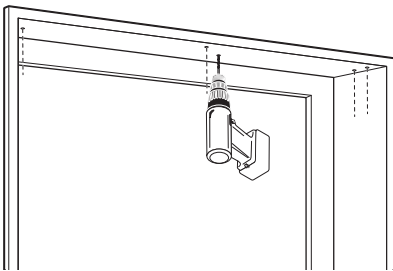

OUTSIDE MOUNT

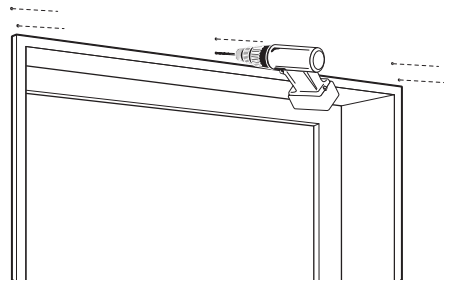

4

INSTALL MOUNTING BRACKETS USING SUPPLIED SCREWS

IMPORTANT: Use the same holes for all brackets to ensure even projection from the surface.

- While holding the brackets in place, secure the brackets using two screws per bracket.

INSIDE MOUNT

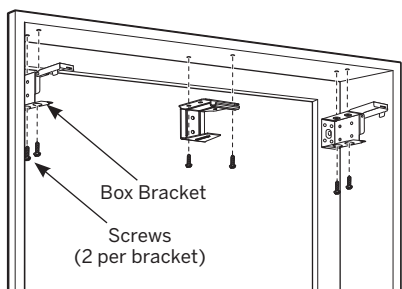

OR

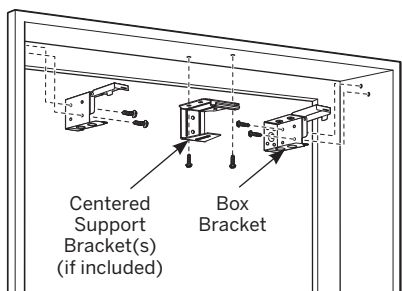

OUTSIDE MOUNT

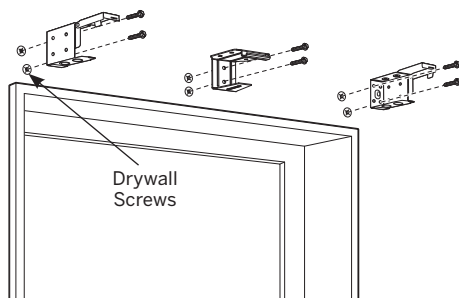

CAUTION: Use drywall anchors (not provided) on outside mounts into drywall. Failure to properly anchor shade could cause shade to fall possibly resulting in injury.

IF YOU ORDERED OPTIONAL EXTENSION BRACKETS OR SPACER BLOCKS

OPTIONAL EXTENSION BRACKET OUTSIDE MOUNT

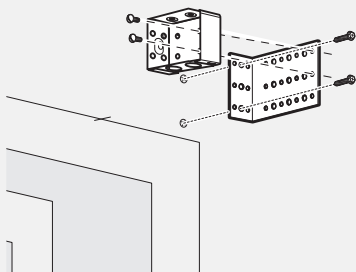

- Position the extension brackets to the desired wall location and mark the position. Ensure bracket tops are aligned and level to one another.
- Mount the extension brackets through the back holes with two screws.
- Attach installation brackets to extension brackets with included screws & nuts.

OPTIONAL EXTENSION BRACKET SIDE MOUNT

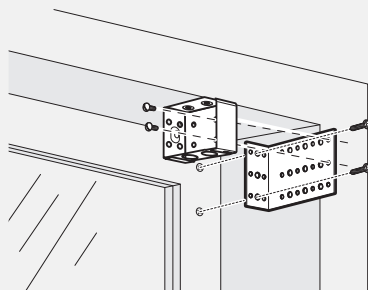

- Measure from window sill up to desired mounting position on each side of the window frame and mark the position.
- Mount extension brackets on each side of window frame. Make sure to confirm that the headrail will sit perfectly level.
- Attach the mounting brackets using the nuts and bolts provided.

IMPORTANT: Use the same holes for all brackets to ensure even projection from the surface.

OPTIONAL SPACER BLOCK OUTSIDE MOUNT

- Outside mounting spacer blocks will provide an additional 3/8" clearance.
- If spacers are used, longer screws may be required to ensure a secure installation (not provided).

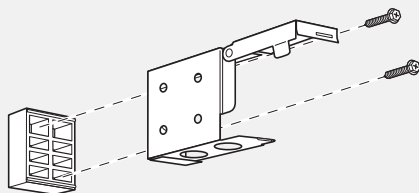

CAUTION: Do not use more than one spacer block. Using more than one spacer block could cause blind to fall resulting in possible injury.

5 INSTALL VALANCE (OPTIONAL)

IMPORTANT: For inside mount, install valance prior to installing blind.

- Locate the valance clip location indicators on the backside of the valance that read "Clip Here".
- Insert the clips into the groove on the backside of the valance. Rotate so that the end marked "TOP" arrow is pointing up.
- For valance returns, insert L-shaped return clip into the groove on the backside of the valance return. Align and insert the other end of the L-shaped return clip into the groove on the backside of the valance.
- Align the clips with the slots on the bottom of the headrail and clip into place.

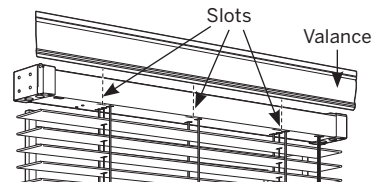
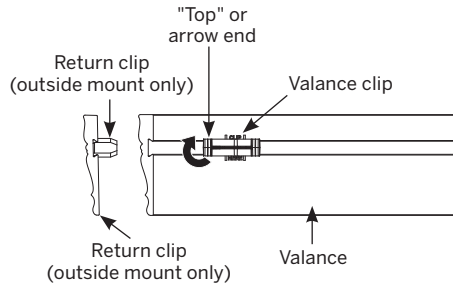

6 MOUNT BLIND INTO THE BRACKETS

- Align the headrail with the brackets, tilt mechanism facing out.
- Slide the headrail straight back into the brackets.
- If the headrail can slide from side to side in the box brackets, use a flat-head screwdriver to bend out the tabs on the ends of the headrail until it is snug.
- If center support bracket(s) are included, hook the front edge of the headrail into the bracket.
- Once blinds are in place, lower the front of each box bracket and press until the locking tab clicks.

CAUTION: Be sure the bracket and headrail are properly secured before operating the blind. Failure to do so may result in the blind falling and possible injury.

INSIDE MOUNT

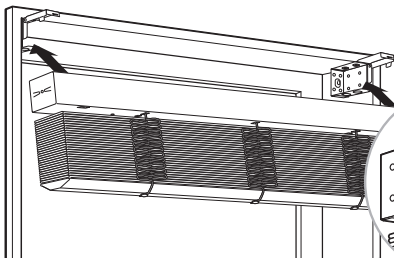

OUTSIDE MOUNT

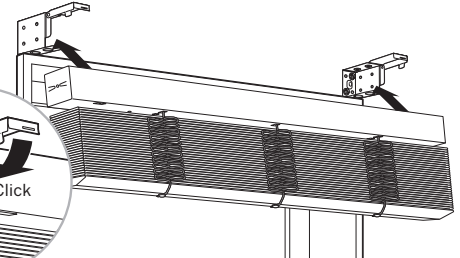

HOLD-DOWN BRACKETS (OPTIONAL)

- Ideal for doors, hold-down brackets prevent blind from swaying. Assemble as shown to each side of bottom rail.

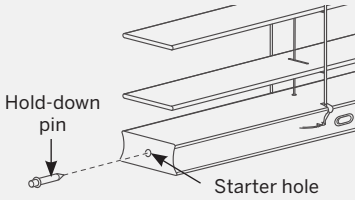

INSIDE MOUNT

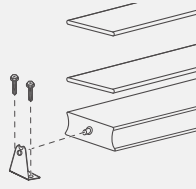

OUTSIDE MOUNT

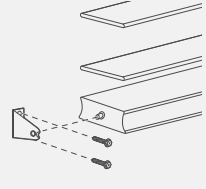

TILT WAND (ON SOME STYLES)

- Pull up the sleeve on the tilt mechanism.
- Clip the end of the wand onto the tilt mechanism and pull down the sleeve on the tilt mechanism.
- Rotate the tilt wand in each direction to ensure proper operation.

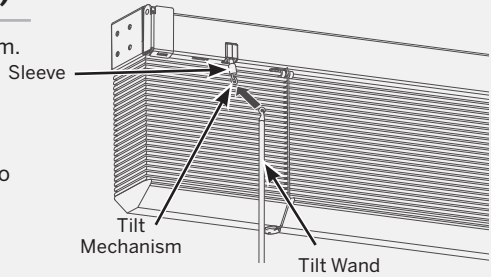

OPERATION

RAISE AND LOWER SHADE

- To raise the blind, firmly press and hold the LEVOLOR button located on the bottom rail and lift the blind to the desired position. Once desired position is reached, release grip on the button to lock blind in place.
- To tilt slats open and closed, rotate the tilt wand to achieve desired position.

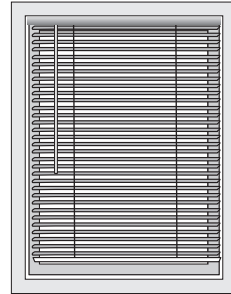

REMOVING THE SHADE

- First make sure that the blind is fully raised. Unlock and lift the front clips of each end box bracket and slide the headrail out of the brackets. If center support brackets are used, lift the front of the headrail up to clear the channel of the bracket and slide out forward.

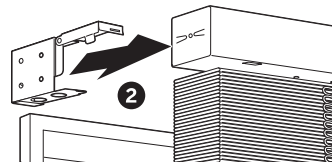
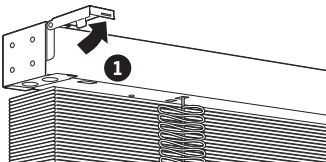

! WARNING ! ADVERTENCIA

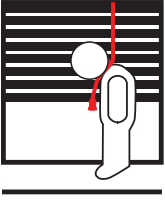

Window Blind Cord Strangulation Risk

Window blinds with a damaged or loose tension device or retractable cord that fails to fully retract pose a strangulation risk to children. To avoid this potential strangulation risk, consider purchasing cordless products or products with inaccessible cords.

Riesgo de Estrangulamiento en Cuerdas de Persianas

Las persianas con un dispositivo tensor suelto o dañado o con una cuerda retráctable que no se ajusta completamente representan un riesgo de estrangulación para los niños. Para evitar un posible riesgo de estrangulamiento, considere comprar productos inalámbricos o productos con cuerdas inaccesibles.