

Outdoor Pole Operated Sun Shade with PVC Fabric

Tools and Tips



Help Videos

We recommend two (2) people install this shade. Retain these instructions for future use. A power drill, tape measure, leveling device, and Phillips screwdriver bit are recommended for installation (not included). This shade must be installed into wood studs. If wood studs are not available, anchoring hardware must be used (not included - see your local hardware store).

Note: your parts and fabric may differ in color than shown in this manual. Parts shown are not to scale. Pre-installed parts are not shown in the part list below.

Parts in hardware box (parts not shown to scale)



Plug Bracket
(PBNV19) x 1



Crank Bracket
(CBNV19) x 1



Bungee Tie Down
(BUN19) x 2



Screws
(S09) x 6



Ring
(R14) x1



Ring Screw
x1



Ring Screw
Lock Washer
x1

Parts in pole package (parts not shown to scale)



Handle x 1



Handle Connector x 1



Pole with Handle x1



Pole Connector x2



Pole Extender x2

item #PLP21-ADJ



Hook x1



Pole Lock
Washer x7



Pole Screw x7

STEP 1: Install the Crank Ring

-Using the Ring Screw, and Large Lock Washer provided in the hardware box, attach the Ring to the Crank Mechanism (Fig. A).

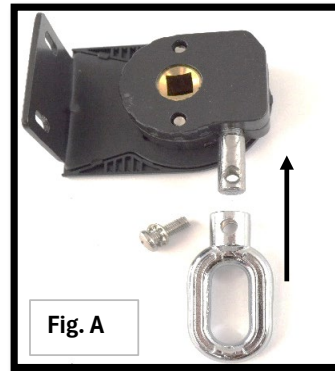

Fig. A

STEP 2: Determine Your Installation

-Your shade can be installed against a wall (Fig B) or under a ceiling/overhang (Fig C). **Your crank and plug brackets are prepared for a wall installation.**

-**IMPORTANT:** the ring on the crank bracket must always point down

-**IMPORTANT:** Plug Bracket clip must open upward

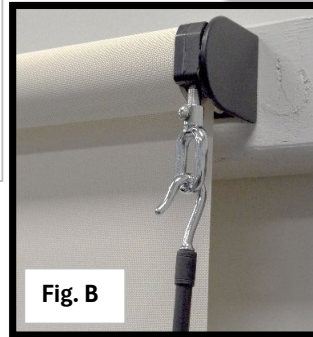

Fig. B

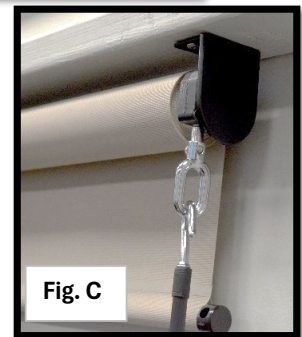

Fig. C

- By default, your shade is prepared for a wall installation (Fig. D) and comes with the Crank Bracket on the right side of the shade. **If wall installation is acceptable, please proceed to step 3.** If you require a ceiling installation you will need to make a changes to **both** of your brackets.

- To change your brackets, begin by removing your bracket covers (Fig F). Remove the 3 screws from the Plug Bracket (Fig G) and the 2 screws from the Crank Bracket (Fig H).

- After removing the screws from both brackets rotate the hardware to match the installation configuration shown in Figure E, and reinstall screws (see help video below)

-**IMPORTANT:** failure to correctly modify both brackets for a ceiling installation can result in the shade falling

-**IMPORTANT:** the ring on the crank bracket must always point down

-**IMPORTANT:** Plug Bracket clip must open upward

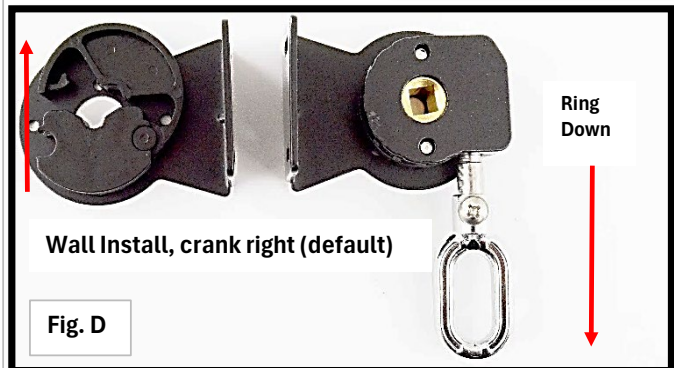

Fig. D



Fig. E

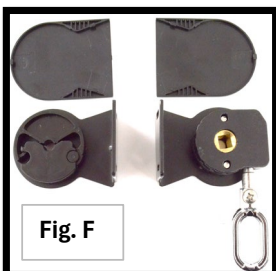

Fig. F

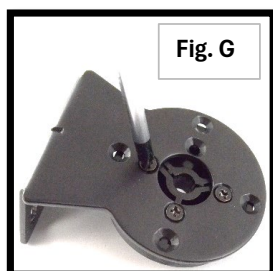

Fig. G



Fig. H



Change Bracket from Wall to Ceiling installation

Optional Steps

1) Move Ring from Right to Left Side

If you would like to move your Ring from the right side (default) to the left side, scan the QR code on the right:



Move Ring from Right to Left Side

2) Move Ring from Front to Back of Shade

You have the options of moving your Ring from the front side of the shade (default) to the back side of the shade. To do this, you must also change the roll direction of your fabric to avoid the fabric from fraying scan the QR code on the right:



Move Ring from Front to Back & Change Roll Direction

STEP 3: Mark holes for installation

- An installation template has been provided to help position your pilot holes. To use the template, temporarily attach your template to your mounting surface (Fig. K) and drill your pilot holes in the four shaded areas as shown in Fig. L. Remove the template before moving to the next step. Double check that your template is level prior to drilling.

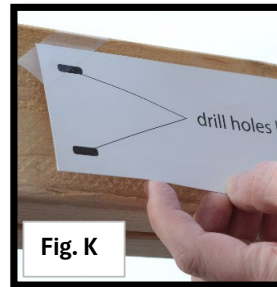

Fig. K



Fig. L

STEP 4: Install Brackets

Using the provided screws, install the Crank Bracket and Plug Bracket (Fig M and N). Note: For a standard installation, the Crank Bracket should be placed on the right side of the shade and the Plug Bracket should be placed on the left side of the shade.

-IMPORTANT: the ring on the crank bracket must always point down

-IMPORTANT: Plug Bracket clip must open upward

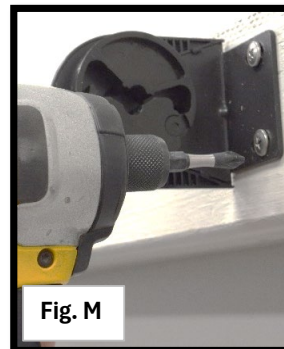

Fig. M

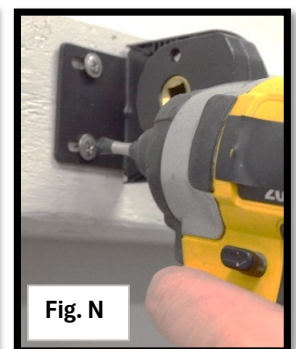

Fig. N

STEP 5: Install Shade

To install your shade, start by inserting the Crank Plug into the Crank Bracket (Fig O).

Next rotate/open the Plug Bracket and insert the shade, making sure to hear a “**click**” as the pin locks into place upon closing (Fig P).

Please refer to Fig. Q for an open Plug Bracket and Fig. R for a closed Plug Bracket after the “**click**”.

If your shade moves side-to-side after installation, we recommend that you adjust the brackets to reduce any lateral movement between the shade and the brackets.

To reduce lateral movement, roll your shade down and loosen the screws on both of your brackets slightly. Push the brackets in, (towards each other), to reduce the distance between the brackets. Re-tighten your screws.

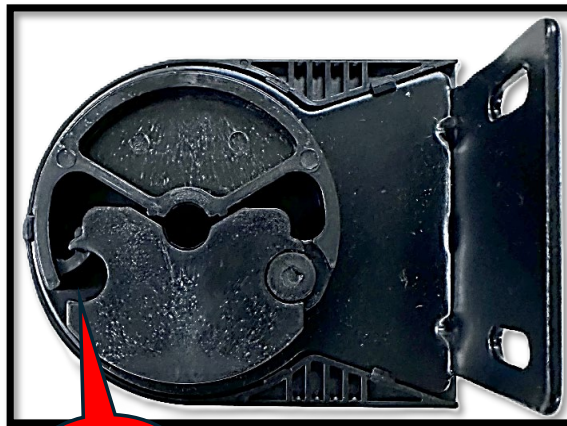
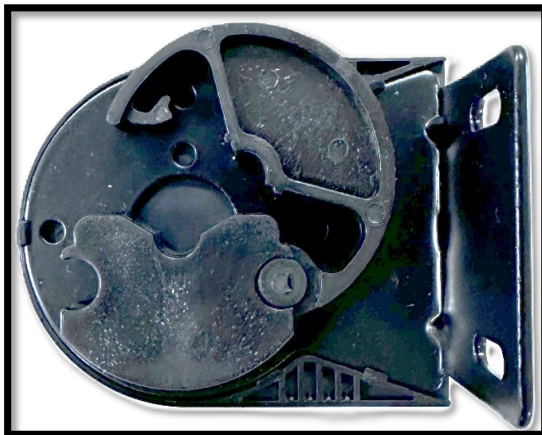
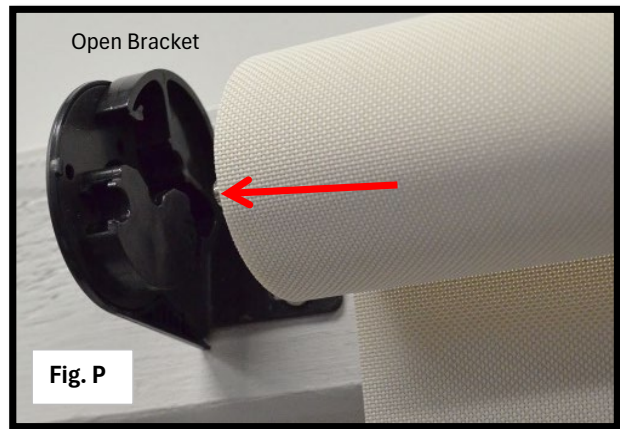
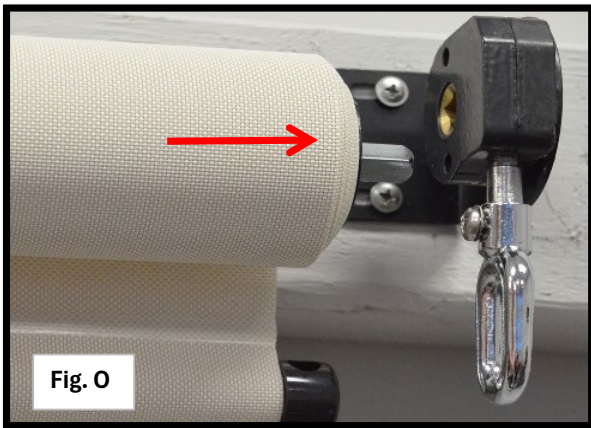

Open vs. Close Plug
Bracket

STEP 6: Assemble Pole

Before you begin, please note that your Pole can be assembled to be any of the following three (3) lengths:

- 2 ft. long
- 4 ft. long
- 6 ft. long

Using two (2) Pole Screws and two (2) Lock Washers, attach the Handle to the Pole with Handle using the Handle Connector (Fig S).

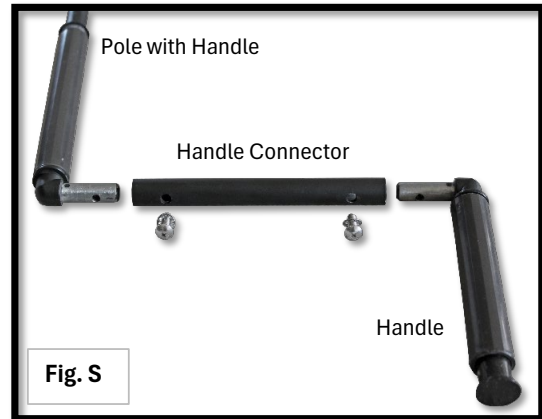

For a 2ft. Pole:

- attach the Hook to the Pole with Handle (see Fig. T)

For a 4ft. Pole:

- Attach a Pole Extender to the Pole with Handle (See Fig. U)
- one [1] Connector Piece
- two [2] Pole Screws
- two [2] Lock Washers
- Attach the Hook to the Pole Extender (Fig T).

For a 6ft. Pole:

- Attach a Pole Extender to the Pole with Handle (See Fig. U)
- one [1] Connector Piece
- two [2] Pole Screws
- two [2] Lock Washers
- Connect the two (2) Pole Extenders to each other using a Pole Connector.
- Attach the Hook to the Pole Extender (Fig T).

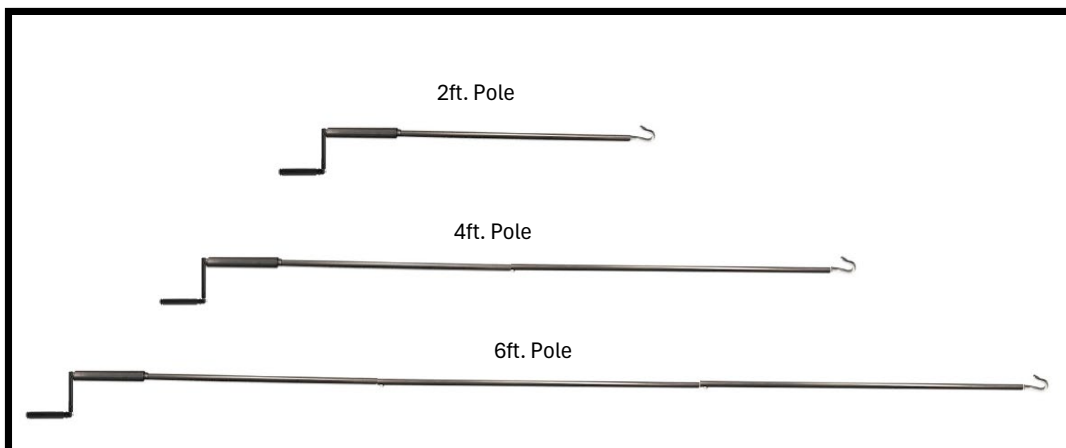
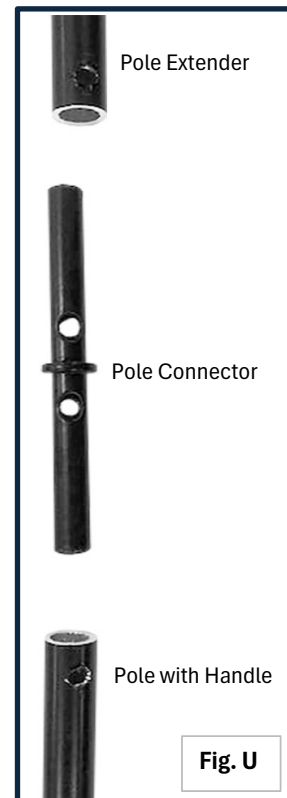

STEP 7 (optional): Install Bungee System

- The shade includes two (2) Bungee Tie Downs to secure the bottom of both sides of your shade.
- To install the Bungee System, start by feeding the Bungee through the Bottom Tube Plugs located at each end of your Bottom Tube (Fig. V).
- Then insert the Bungee into the Hook and drill the Hook into a wall/post using one (1) Bracket Screw from your hardware box.
- To prevent fabric stretching/damage, hooks should be installed directly underneath the Bottom Tube Plugs so there is equal tension on each bungee.
- See help video with the QR code on the right side of this page

IMPORTANT: Your shade should be rolled up during windy conditions (up to 12mph). The Bungee System is only effective in light wind. When using your shade, we recommend leaving at least one (1) roll of fabric wrapped around the top tube.

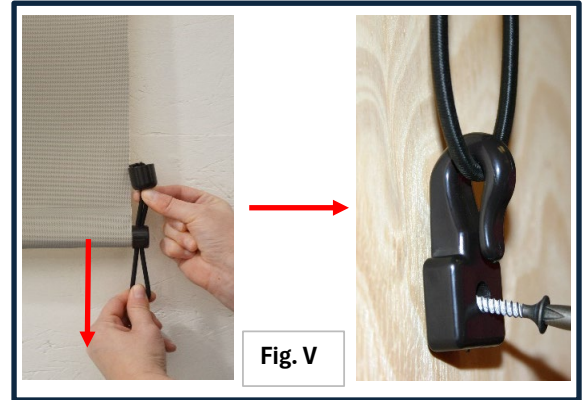

Need Help?

Installation videos are available at www.AmatrriaOutdoor.com.

Maintenance

To clean your shade simply rinse with water and scrub with any non-abrasive cleaner (using bleach or other abrasive cleaners will void your warranty). Roll the shade down to air dry.

Warranty and Limitation of Liability

We will cover any manufacturing defect of the hardware for your shade for a period of two (2) years and the fabric for your shade for a period of five (5) years from the date of purchase. This warranty does not cover color fading of the hardware or fabric due to sun exposure, damage due to faulty installation (e.g., installing the shade onto an unstable surface, using shorter screws than those originally included, etc.) or misuse of the shade or hardware (e.g., leaving the shade down in high winds, exposure to chemicals/open flames, etc.). If your claim relates to a shade part, we will either help you to repair the part, or we will replace the part. If your claim relates to the fabric or valance, please contact us so we can determine if the issue can be fixed or if the shade will need to be returned. We will not pay for installation costs or to have shade parts repaired by an independent repair person. Any alterations made to your shade or hardware (e.g., cutting the fabric, making changes to the clutch assembly, etc.) will void your warranty. Proof of purchase (detailing price paid, date purchased, and place purchased) is required for all warranty claims. Important: this warranty is only valid if the shade has been purchased from an authorized reseller.